



# LITECON CONFINED WALLS

## INSTALLATION GUIDE

PRODUCT:

## LITECON CONFINED WALLS

# INDEX

---

INDEX	I
BEFORE STARTING	01
BLOCKS DIMENSIONS	02
ADHESIVE APPLICATION	03
WALL SUPPORT ON FOUNDATION OR TIE BEAM	04
CORNER WALL AND INTERSECTIONS	05
DETAIL IN DOORS AND WINDOWS	06
CRACKS REPAIRING	07

---

PRODUCT:

LITECON CONFINED WALLS

## BEFORE STARTING

---

- 1.- LITECON BLOCK
  - 2.- LITECON ADHESIVE
  - 3.- FIBERGLASS MESH
  - 4.- TAP WATER
  - 5.- ELECTRIC POWER 110/220V
  - 6.- A EMPTY BUCKET
  - 7.- GROUT MIXING PADDLE
  - 8.- ELECTRIC DRILL
  - 9.- BATTERY SCREWDRIVER
  - 10.- RUBBER HAMMER
  - 11.- BUBBLE OR LASER KNIFE
  - 12.- JOINT KNIFE
  - 13.- CIRCULAR SAW
  - 14.- 7" DIAMOND TURBO BLADE
  - 15.- SILICONE WATERPROOF FOR WINDOWS
  - 16.- BACKER ROD FOR WINDOWS
  - 17.- REBARS
  - 18.- CONCRET
-

PRODUCT:

LITECON CONFINED WALLS

## BLOCKS DIMENSIONS

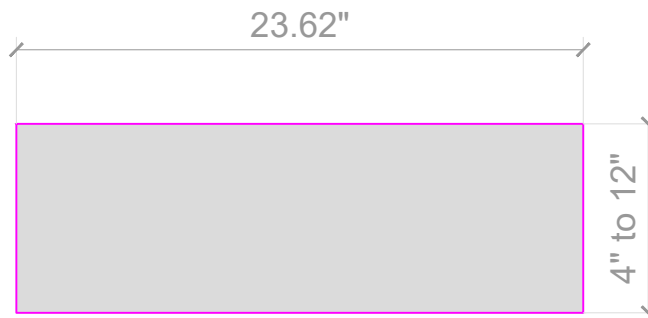
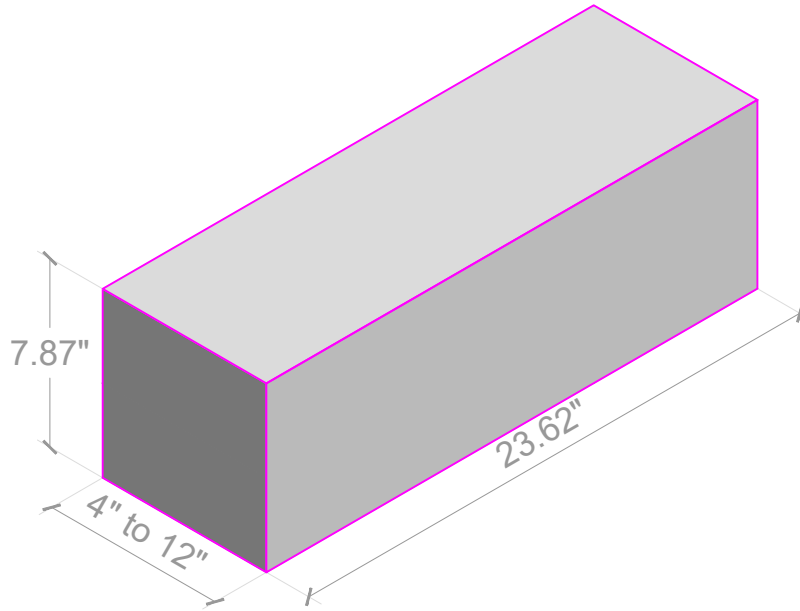

PRODUCT: **LITECON CONFINED WALLS**

## ADHESIVE APPLICATION

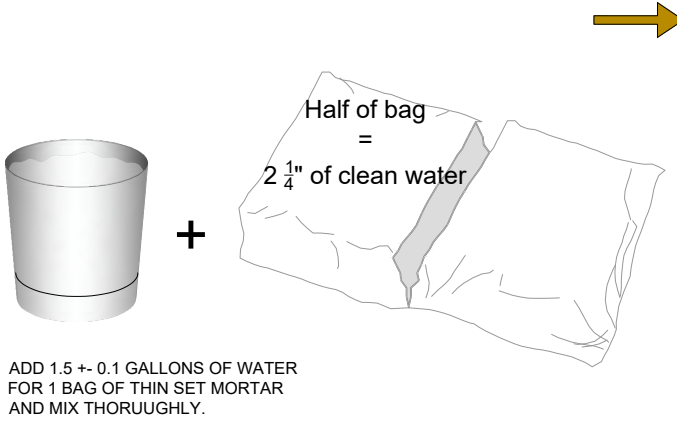

1.- APPLY ENOUGH ADHESIVE, AT LEAST 1/16" THROUGHOUT EVERY MATING FACE

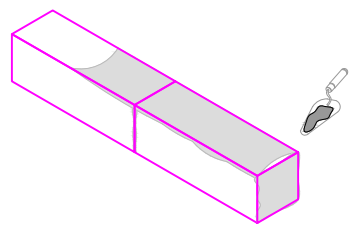

3.- AFTER THE REINFORCE WALL IS INSTALLED SMOOTHEN THE AREA WHERE THE LITECON ADHESIVE SPAT OUT



2.- APPLY ENOUGH LITECON ADHESIVE SO THAT IT SPITS OUT ONCE THE BLOCK IS INSTALLED

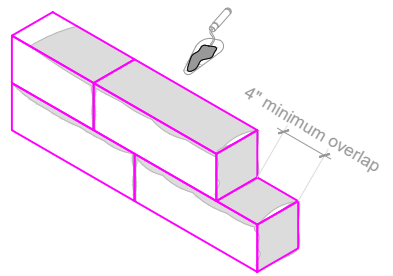
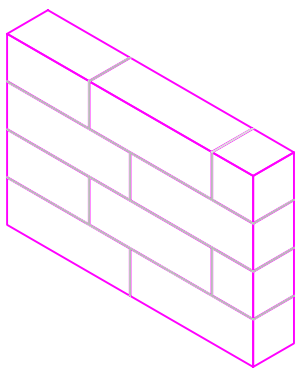

**WALL SUPPORT ON FOUNDATION OR TIE BEAM**

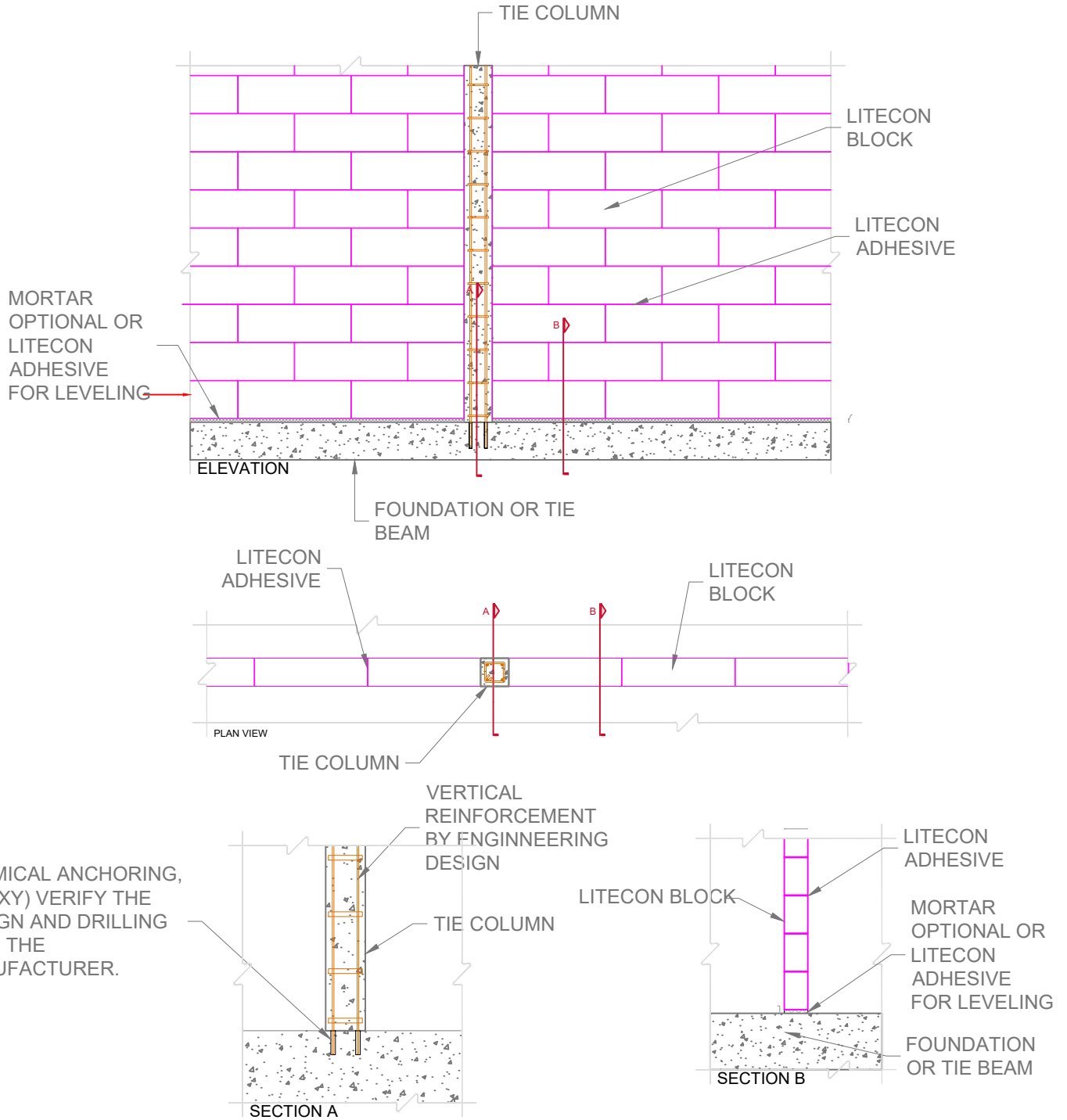

**NOTES**

- 1.- THE DIMENSIONS, QUANTITY, AND SPACING OF THE TIE COLUMNS AND BOND BEAMS MUST BE PROPOSED BY THE PROJECT ENGINEER.

PRODUCT: **LITECON CONFINED WALLS**

## CORNER WALL AND INTERSECTIONS

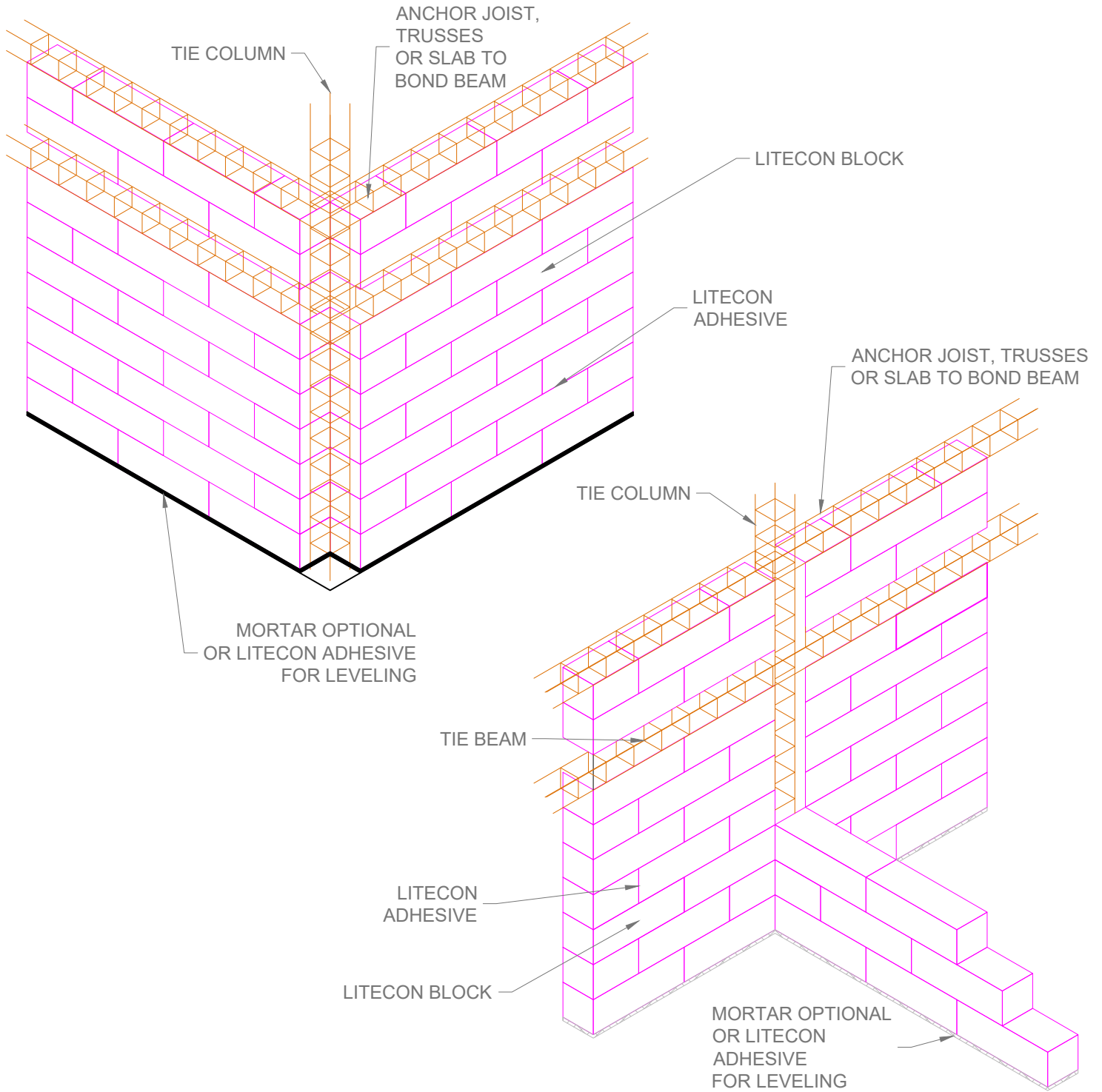

### NOTES

- 1.- THE DIMENSIONS, QUANTITY, AND SPACING OF THE TIE COLUMNS AND BOND BEAMS MUST BE PROPOSED BY THE PROJECT ENGINEER.

PRODUCT: **LITECON CONFINED WALLS**

## DETAIL IN DOORS AND WINDOWS

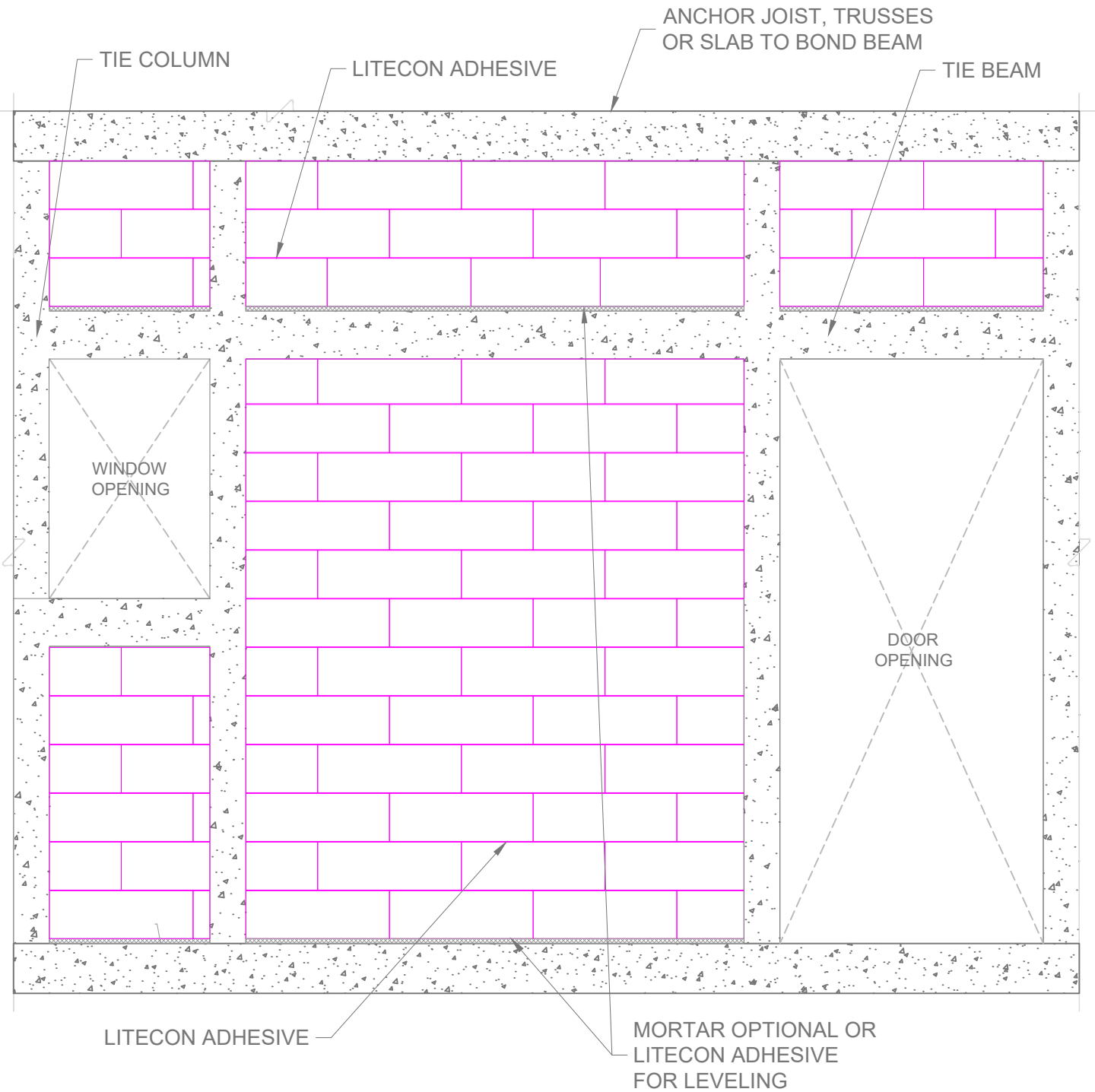

### NOTES

- 1.- THE DIMENSIONS, QUANTITY, AND SPACING OF THE TIE COLUMNS AND BOND BEAMS MUST BE PROPOSED BY THE PROJECT ENGINEER.

PRODUCT:

LITECON CONFINED WALLS

## CRACKS REPAIRING

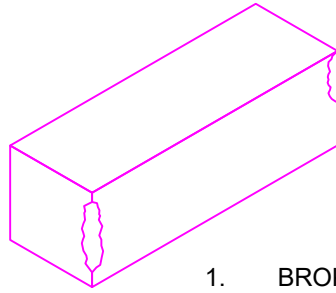

1. BROKEN BLOCK

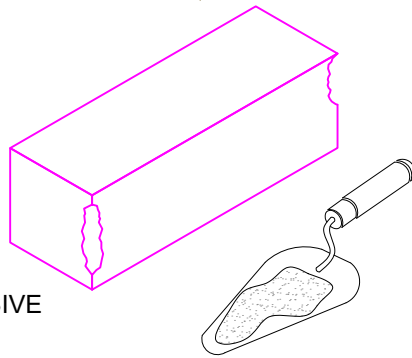
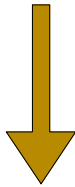

2. APPLY LITECON ADHESIVE

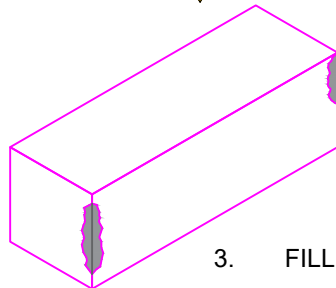
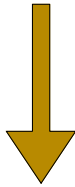

3. FILL WITH LITECON ADHESIVE

### NOTES

- 1.- IF MORE THAN A THIRD OF THE BLOCK IS NOT BROKEN, YOU CAN USE IT.



## LITECON CONFINED WALLS

INSTALLATION GUIDE